

LC-P12120P

DIMENSIONS (MM)



Contents indicated (including the recycle marking, etc.) are subject to change without notice.

FOR STANDBY POWER SUPPLIES.
EXPECTED TRICKLE DESIGN LIFE: 10 - 12 YEARS AT 20°C
ACCORDING TO EUROBAT.

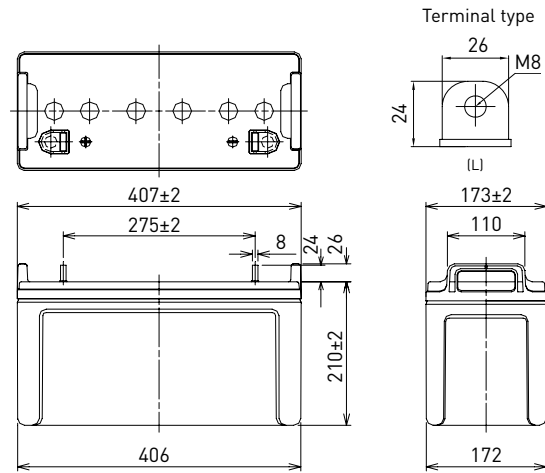

Battery case resin: flame retardant (UL94 V-0)

SPECIFICATIONS

Name		LC-P12120P
Nominal voltage		12V
Nominal capacity (20 hour rate)		120Ah
Dimensions	Length	407mm
	Width	173mm
	Height	236mm
Approx. mass		34.5kg
Terminal		M8 bolt/nut
Capacity (25°C)	20 hour rate	120Ah
	10 hour rate	110Ah
	3 hour rate	93Ah
	1 hour rate	85Ah
Impedance		Fully charged battery (25°C) 4.5mΩ
Temperature dependency of capacity (20 hour rate)	40°C	102%
	25°C	100%
	0°C	85%
	-15°C	65%
Self-discharge (25°C)	After 3 month	91%
	After 6 month	82%
	After 12 month	64%

DURATION OF DISCHARGE VS. DISCHARGE CURRENT

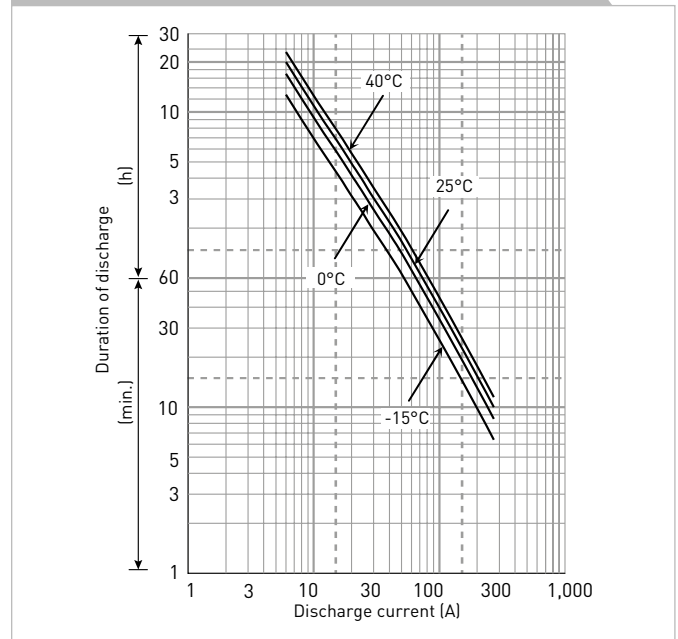

WATT TABLE (25°C)

Cut-off	5min.	10min.	15min.	20min.	30min.	45min.	1h	1.5h	2h	3h	4h	5h	6h	10h	20h
9.6V	3,603	2,883	2,296	2,036	1,409	1,095	835	663	499	326	261	197	179	104	60.2
9.9V	3,537	2,849	2,285	2,024	1,370	1,062	820	662	486	322	255	191	177	103	60.1
10.2V	3,309	2,776	2,273	2,001	1,322	1,040	805	642	479	315	249	185	168	102	60.0
10.5V	3,020	2,572	2,148	1,907	1,316	1,025	779	629	470	310	246	184	166	101	60.0
10.8V	2,916	2,294	2,079	1,861	1,281	980	756	559	458	306	240	180	163	99.8	59.9

AMPERE TABLE (25°C)

Cut-off	5min.	10min.	15min.	20min.	30min.	45min.	1h	1.5h	2h	3h	4h	5h	6h	10h	20h
9.6V	361	271	211	181	139	105	86.9	59.3	47.9	32.1	23.7	20.6	17.4	11.1	6.00
9.9V	357	267	210	180	138	102	86.6	58.1	47.5	31.5	23.4	20.4	17.3	11.1	6.00
10.2V	348	261	209	178	136	97.0	85.9	57.7	46.9	31.2	23.2	20.0	17.2	11.0	6.00
10.5V	322	241	198	170	134	92.0	85.4	56.9	46.3	31.0	23.0	19.9	17.1	11.0	6.00
10.8V	282	211	192	165	132	86.9	74.0	51.2	44.0	29.9	22.7	19.8	16.7	10.9	5.88

All mentioned values are average values

LC-P12120P

CHARGING METHOD (25°C)

Trickle use Control voltage: 13.6V - 13.8V
Initial current: 18.0A or smaller

CUT-OFF VOLTAGE

Discharge current	6.00A - 24.0A	24.0A - 60.0A	60.0A - 120A	120A - 240A	240A - 300A
Cut-off voltage	10.5V	10.2V	9.9V	9.3V	8.7V

INFLUENCE OF TEMPERATURE ON TRICKLE LIFE

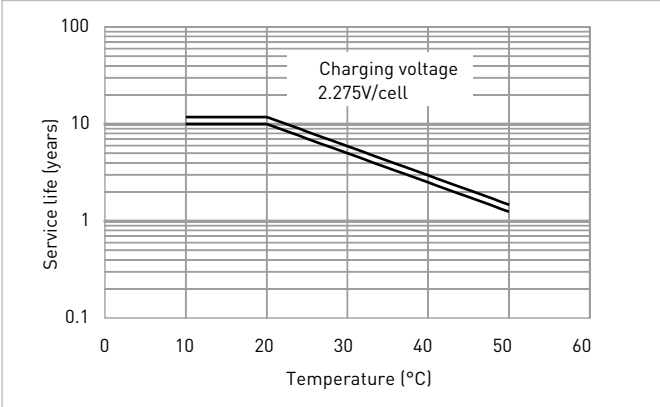

RESIDUAL CAPACITY TEST RESULT

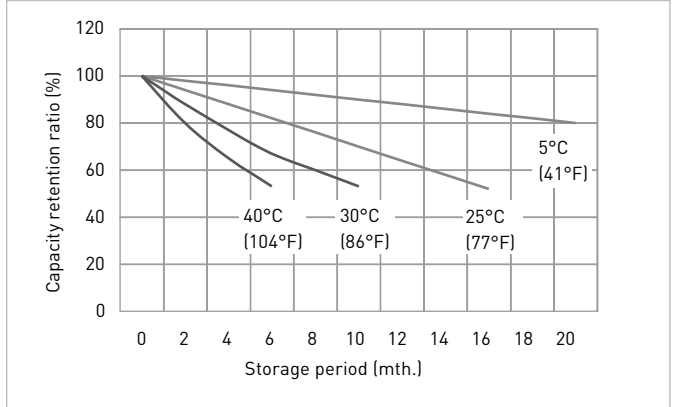

CONSTANT-VOLTAGE CONSTANT-CURRENT CHARGE CHARACTERISTICS FOR TRICKLE USE

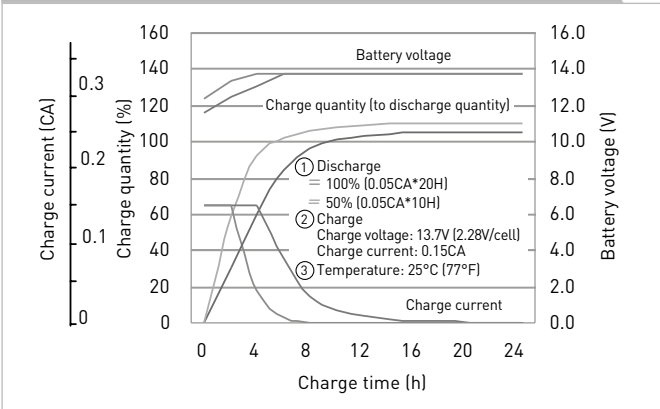

DISCHARGE CAPACITY BY TEMPERATURE AND BY DISCHARGE CURRENT

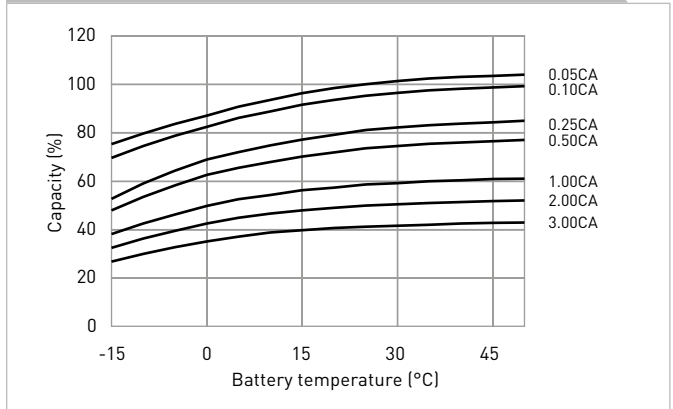

DISCHARGE CHARACTERISTICS

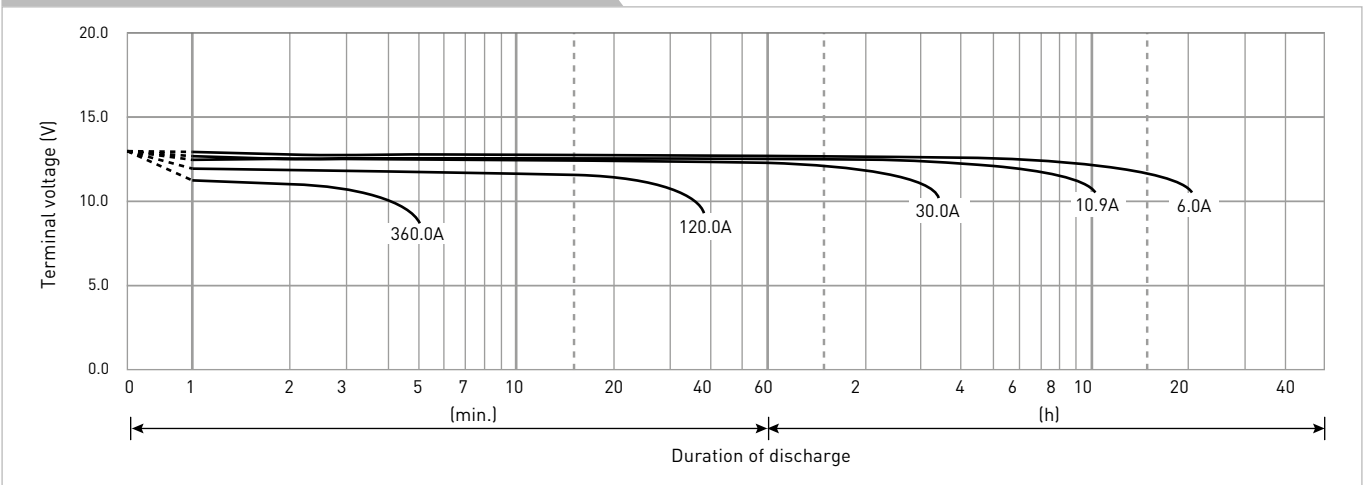

The data in this document are for descriptive purposes only and are not intended to make or imply any guarantee or warranty. Regarding handling and safety please consult our VRLA technical handbook chapter 1.