

LC-CA1212P

FOR MAIN POWER SUPPLIES.
CYCLE LONG-LIFE TYPE

DIMENSIONS (MM)

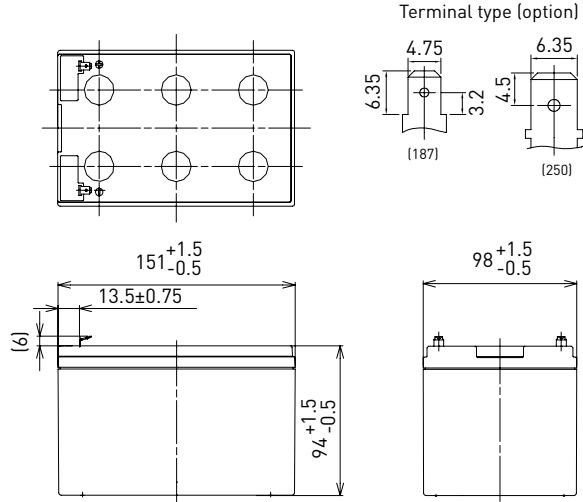

Contents indicated (including the recycle marking, etc.) are subject to change without notice.

Battery case resin: standard (UL94 HB)

SPECIFICATIONS		LC-CA1212P/P1
Name		LC-CA1212P/P1
Nominal voltage		12V
Nominal capacity (20 hour rate)		12Ah
Dimensions	Length	151mm
	Width	98mm
	Height	100mm
Approx. mass		3.80kg
Terminal		Faston 187/250
Capacity (25°C)	20 hour rate	12.0Ah
	10 hour rate	11.0Ah
	3 hour rate	9.3Ah
	1 hour rate	8.5Ah
Impedance		Fully charged battery (25°C) 15mΩ
Temperature dependency of capacity (20 hour rate)	40°C	102%
	25°C	100%
	0°C	85%
	-15°C	65%
Self-discharge (25°C)	After 3 month	91%
	After 6 month	82%
	After 12 month	64%

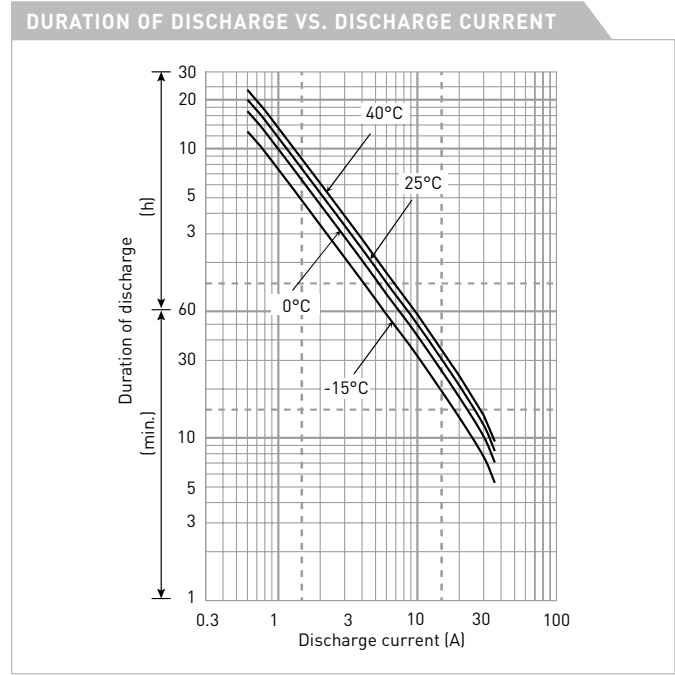

WATT TABLE (25°C)															[Wattage/battery]	
Cut-off	3min.	5min.	10min.	15min.	20min.	30min.	45min.	1h	1.5h	2h	3h	4h	5h	6h	10h	20h
9.6V	679	559	384	298	247	183	137	105	70.3	54.5	38.1	28.8	24.1	21.7	13.3	7.22
9.9V	649	537	373	288	241	177	135	104	69.9	54.2	37.8	28.8	24.1	21.7	13.3	7.22
10.2V	607	506	363	282	235	177	134	102	69.1	53.9	37.5	28.8	24.0	21.6	13.2	7.21
10.5V	556	475	343	271	231	172	133	100	68.5	53.3	36.9	28.7	24.0	21.6	13.2	7.20
10.8V	495	434	321	261	225	166	123	98	66.1	52.1	36.3	28.4	23.8	21.5	13.1	7.18

AMPERE TABLE (25°C)															[Ampere/battery]	
Cut-off	3min.	5min.	10min.	15min.	20min.	30min.	45min.	1h	1.5h	2h	3h	4h	5h	6h	10h	20h
9.6V	61.1	50.1	34.3	25.9	21.3	15.6	11.7	8.90	5.95	4.60	3.20	2.41	2.01	1.81	1.11	0.602
9.9V	58.4	48.2	33.3	25.0	20.8	15.1	11.5	8.80	5.92	4.58	3.18	2.41	2.01	1.81	1.11	0.602
10.2V	54.6	45.4	32.4	24.5	20.3	15.1	11.4	8.70	5.85	4.55	3.15	2.41	2.00	1.80	1.10	0.601
10.5V	50.0	42.6	30.6	23.6	19.9	14.7	11.3	8.50	5.80	4.50	3.10	2.40	2.00	1.80	1.10	0.600
10.8V	44.5	38.9	28.7	22.7	19.4	14.2	10.5	8.30	5.60	4.40	3.05	2.38	1.99	1.79	1.09	0.598

All mentioned values are average values

LC-CA1212P

CHARGING METHOD (25°C)

Cycle use Control voltage 14.5V - 14.9V
Initial current 4.8A or smaller

CUT-OFF VOLTAGE

Discharge current	0.6A - 2.4A	2.4A - 6A	6A - 12A	12A - 24A	24A - 36A
Cut-off voltage	10.5V	10.2V	9.9V	9.3V	8.7V

CYCLE LIFE VS. DEPTH OF DISCHARGE (ACC. IEC 61056)

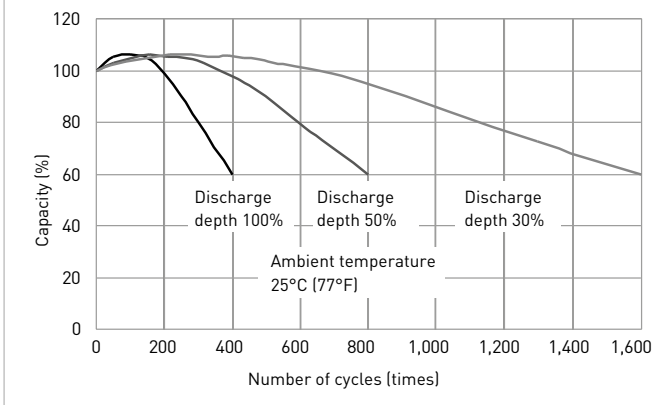

RESIDUAL CAPACITY TEST RESULT

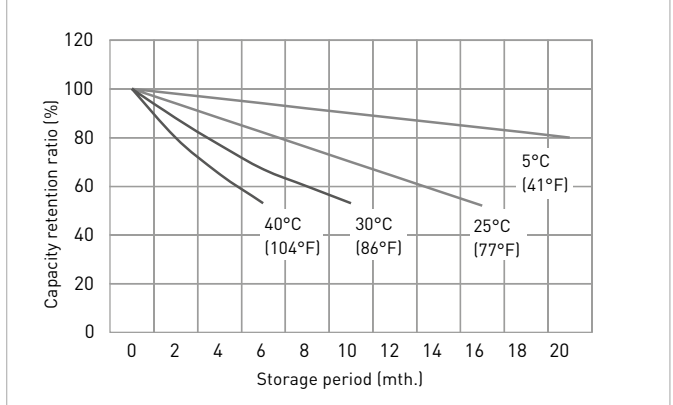

CONSTANT-VOLTAGE CONSTANT-CURRENT CHARGE CHARACTERISTICS FOR CYCLE USE

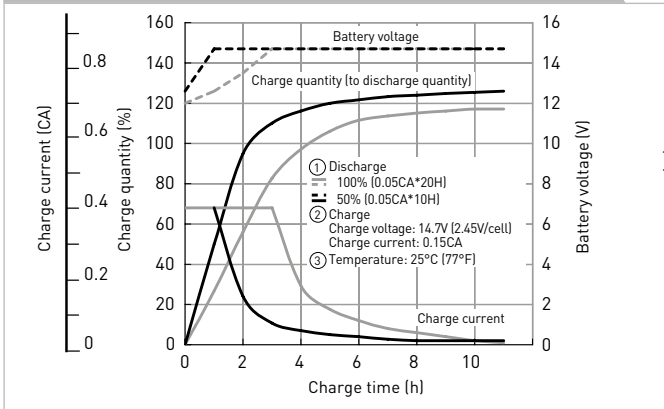

DISCHARGE CAPACITY BY TEMPERATURE AND BY DISCHARGE CURRENT

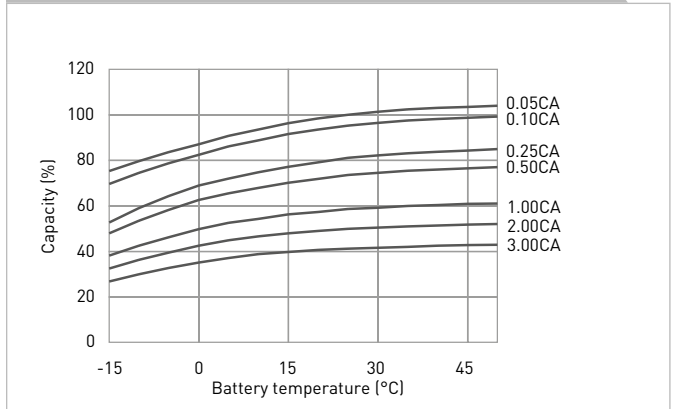

DISCHARGE CHARACTERISTICS

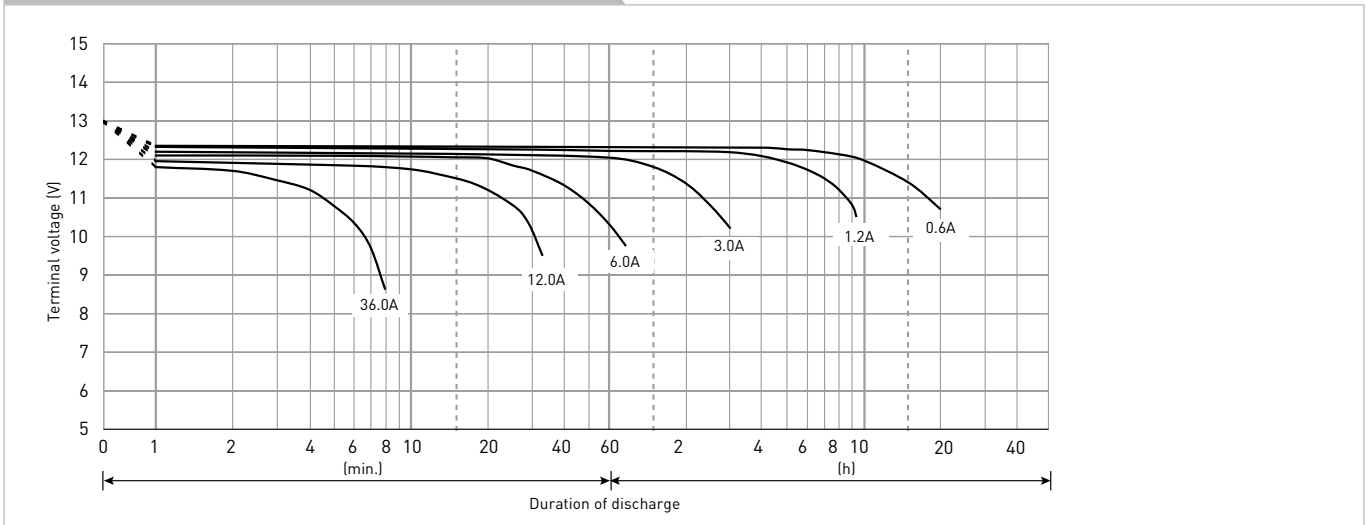

The data in this document are for descriptive purposes only and are not intended to make or imply any guarantee or warranty. Regarding handling and safety please consult our VRLA technical handbook chapter 1.